

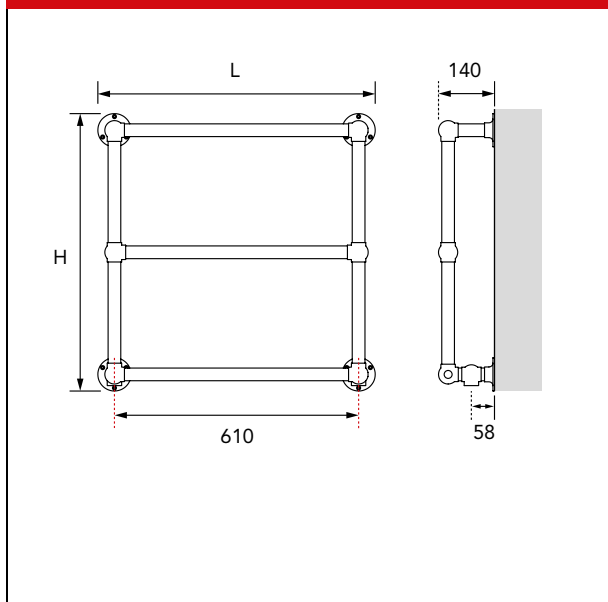

SAXBY

SAXBY is a classic towel warmer design that is both simple and traditional. It is a practical and unobtrusive choice and will subtly enhance your bathroom with the benefit of both style and function. It is manufactured from quality brass and has a highly polished chrome plated finish.

DIMENSIONS



WEIGHT

Model	Weight (kg)
B34/1	7.50

GENERAL SPECIFICATION

- ✓
CERTIFICATION
 Manufactured and tested to BS EN 442. Carries the BS Kitemark. Produced under an environmental management system - ISO 14001:2004.
- 10
GUARANTEE
 10 year guarantee from date of purchase against manufacturing defects.
- 🔧
COLOUR
 Finished in chrome.
- 🔩
MATERIAL
 Manufactured from brass.
- 📦
SYSTEM (INDIRECT)
 2 pipe pumped indirect domestic and commercial heating applications.
- 🔄
SYSTEM (DIRECT)
 Suitable for direct systems. Please refer to page 251 for information on dezincification.
- 🔌
CONNECTIONS
 2 x ½" BSP as standard.
- 🌬️
AIR VENTS
 Integrated.
- 📈
OPERATING PRESSURES
 Tested to a pressure of 6.9 bar. Working pressure of up to 5.3 bar.
- ⚡
DUAL FUEL
 PTC100 dual fuel heater kit available. Please see page 124.
- 🔧
APM® TECHNOLOGY
 PTC heater kit comes with APM® technology. Please see page 251.
- 🚚
DELIVERY
 2 - 5 working days.
- 🔑
VALVES
 Please see page 124.

For more general information, please see page 250.

Order Code	Nominal Height (H) (mm)	Nominal Length (L) (mm)	Heat Outputs @ ΔT 50°C		Heat Outputs @ ΔT 30°C		Dual Fuel Rating
			Watts	Btu/h	Watts	Btu/h	
B34/1	693	693	199*	679*	107*	367*	100

*Outputs NPD, see page 251.