



AUTOMATIC BYPASS VALVES







MYSON offer a selection of Automatic Bypass Valves (ABVs).



ABV22

Our automatic bypass valves are designed for use in domestic central heating systems and are available in either an angled or straight version. Its purpose is to maintain constant pump pressure and flow rate within the system. ABVs also reduce system noise and increase efficiency.

General specification

-  **CERTIFICATION**
Produced under a quality management system - ISO 9001:2008. Pressure tested in accordance with BS 2767.
-  **OPERATING PRESSURES**
Tested to a maximum pressure of 10 bar.
-  **OPERATING TEMPERATURE**
Maximum 120°C.
-  **GUARANTEE**
2 year guarantee from date of purchase against manufacturing defects.
-  **DELIVERY**
2 - 5 working days.
-  **COLOUR**
Finished in brass.
-  **CONNECTIONS**
Compression.

For more general information, please see page 260.

Dimensions

Automatic Bypass Valve Angle

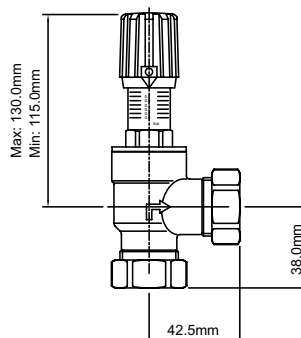

Automatic Bypass Valve Straight

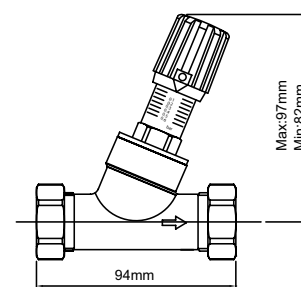

NB: All measurements are nominal.

Description	Metal Finish	Order Code	Minimum Order Qty
Automatic Bypass Valve Angle	Brass	ABV22	1
Automatic Bypass Valve Straight	Brass	ABV22S	1